

IMPROVED

R A C I N G TM

MHX SERIES HIGH-EFFICIENCY HEAT EXCHANGER

MADE IN USA

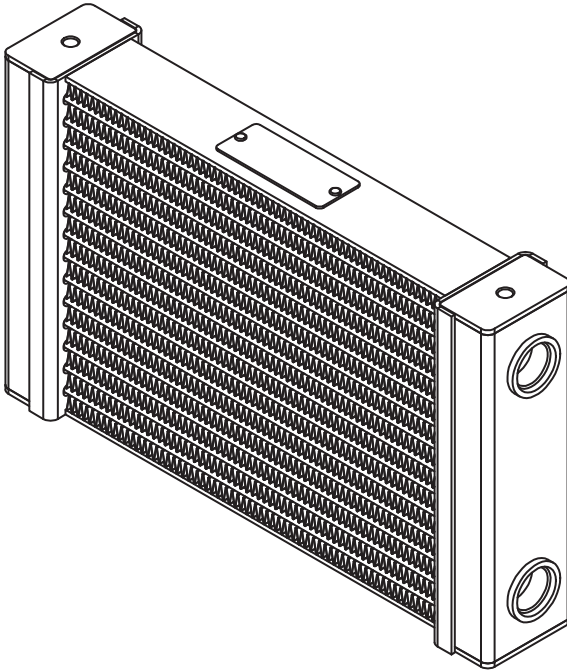

**Important: Read these instructions in their
entirety prior to installation**

For contact information, visit www.improvedracing.com
Copyright © 2008-2020 Improved Racing Products, LLC. All rights reserved.

APPLICATIONS

- Improved Racing's high-efficiency Motorsport Heat Exchangers (MHX) are suited for fluid cooling applications such as:
 - Engine Oil
 - Transmission, Transaxle, Differential & Transfer Case Fluid
 - Supercharger Coolant
 - Small-Engine Coolant
-  **Not for use with highly corrosive fluids**

DIMENSIONS AND CAPACITIES

Part No.	Rows	Passes	Ports	Weight	Capacity
MHX-206	6	1	-10AN Female ORB	1.0lbs (0.45 kg)	0.23 Qt (0.22 L)
MHX-214	14	2	-10AN Female ORB	1.9 lbs (0.86 kg)	0.60 Qt (0.57 L)
MHX-220	20	2	-10AN Female ORB	2.5 lbs (1.1 kg)	0.95 Qt (0.90 L)
MHX-245	45	3	-10AN Male JIC	5.1 lbs(2.3 kg)	1.95 Qt (1.85 L)
MHX-245C	45	3	-10AN Male JIC	5.4 lbs (2.6 kg)	1.95 Qt (1.85 L)
MHX-514	14	2	-10AN Female ORB	2.9 lbs (1.3 kg)	0.75 Qt (0.71 L)
MHX-520	20	2	-10AN Female ORB	3.8 lbs (1.7 kg)	1.04 Qt (0.98 L)
MHX-530	30	2	-10AN Female ORB	5.4 lbs (2.45 kg)	1.56 Qt (0.95 L)

TECHNICAL SPECIFICATIONS

Maximum Operating Temperature	302°F (150°C)
Minimum Operating Temperature	-22°F (-30°C)
Maximum Operating Pressure	150 psi (10.34 bar)
Test Pressure	175 psi (12.07 bar)
Fitting Ports	-10 Straight Thread SAE J1926-1 / MS16142 (ISO 11926-1) O-ring port OR -10 SAE 37° JIC Male
Heat Exchanger Material	Aluminum
Fabrication	Tube & fin core w/turbulators, TIG welded tanks, billet CNC-machined end caps
Mounting Screw Hole Size	M8 x 1.25, 12mm depth

PLUMBING ORIENTATION

- The preferred plumbing orientations are shown in Figures 1 and 2.
 - ⚠ Plumbing the heat exchanger with ports facing down may result in air pockets, which can adversely affect performance.
 - ⚠ Mounting the heat exchanger higher than the sump may require an in-line check valve or use of a filter with a drain back valve to prevent fluid from draining back into the sump when not in use.

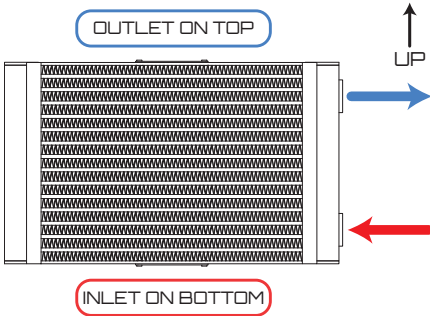

Figure 1 - Horizontal Plumbing

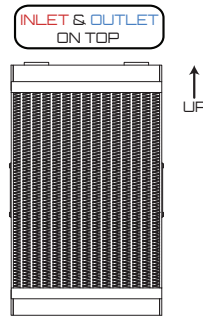







Figure 2 - Vertical Plumbing

MOUNTING THE HEAT EXCHANGER

- For the best performance, install the heat exchanger where it will receive direct airflow.
- Push / pull fans should be used where airflow is limited. Peak performance will be limited by the fan's air flow rate.
 - 💡 Improved Racing offers fan kits for several MHX heat exchangers.
 - ⚠ Do not mount fans directly to the core with pull ties. This will damage the heat exchanger and will void the warranty.
- The heat exchanger must be isolated from vibration and stresses caused by heat expansion and contraction. Use Improved Racing's rubber-isolated mounting brackets for MHX series coolers.
 - ⚠ Do not hard mount the heat exchanger without rubber isolation.
 - ⚠ Leaks and failures caused by improper mounting are not covered by the warranty.
- Use only the mounting holes located on the end tanks to secure the heat exchanger to the brackets.
 - The heat exchanger must be supported by at least three of the four

mounting points.

INSTALLATION INSTRUCTIONS

1. Select an installation location for the heat exchanger.
-  Select a location that receives maximum airflow while in use.
2. If applicable, install the AN adapter fittings to the heat exchanger.
-  Lubricate the -AN fitting O-rings with engine oil to prevent O-ring damage.
-  Use aluminum wrenches to avoid damaging the aluminum fittings.
3. Torque the AN fittings to a maximum of 32 lb-ft (43 N-m).
-  **DO NOT exceed fitting torque of 32 lb-ft (43 N-m).**
4. Configure and assemble the lines.
5. If possible, pre-fill the heat exchanger before connecting the lines.
6. Connect the lines to the heat exchanger and fluid supply.
7. Secure the heat exchanger using a minimum of three of the four M8 mounting holes.
-  Ensure the heat exchanger is isolated from vibration.
-  For best results, use Improved Racing's mounting brackets.
8. Inspect and top-off the fluids as needed.
9. Prime the system with fluid, if applicable. For engine oil, this may be accomplished by removing the fuel pump fuse or disconnecting the ignition circuit, then cranking the engine for several seconds.
10. Test the system and inspect for leaks.
11. Turn off the system and inspect the fluid level. Add fluid if necessary.
12. Re-inspect the lines and fittings for leaks after 1-2 heat cycles and re-tighten fittings if necessary.

Installation is now complete. Thank you for purchasing an Improved Racing product!